

## TRIPODAL LIGANDS WITH MIXED DONORS. SYNTHESIS OF 2-DIPHENYLPHOSPHINOMETHYL-2-PHENYLTHIOMETHYL-1-METHOXYPROPANE (PSO) AND ITS TRANSITION METAL COMPLEXES

SHIUH-TZUNG LIU,\* CHONG-LUNG TSAO, MING-CHU CHENG and SHIE-MING PENG

Department of Chemistry, National Taiwan University, Taipei, Taiwan 10764, R.O.C.

(Received 20 March 1990; accepted 7 June 1990)

**Abstract**—A tripodal ligand containing phosphorus, sulphur and oxygen donors has been synthesized and its coordination in chromium(0), molybdenum(0), tungsten(0), manganese(I) and palladium(II) complexes has been investigated. X-ray crystal structures of the chromium, tungsten and palladium compounds have been determined, and the conformations of the six-membered chelate rings of these complexes are discussed.

The design of new polydentate ligands for coordination studies has been interesting and challenging work. As part of our interest in tripodal terdentate ligands, we wished to synthesize such species which contain both "soft" and "hard" donor sites. Such ligands could be used to study the selectivity studies toward transition metals. In our early work,<sup>1</sup> we described several tripodal ligands that contain only two different donor sites, **1** and **2**. However, tripodal terdentates containing three different donor atoms would be more attractive for coordination chemists. Only a few such species have been reported,<sup>2,3</sup> and none containing phosphorus. Here, we report the synthesis of a tripodal phosphine ligand with three different donors, 2-diphenylphosphinomethyl-2-phenylthiomethyl-1-methoxypropane (abbreviated as PSO) **3**, and its complexation toward various transition metals.

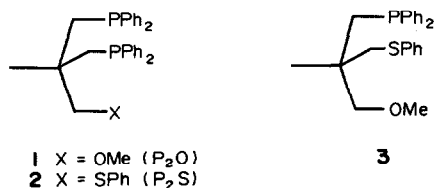

## RESULTS AND DISCUSSION

### Synthesis of ligand

The synthetic approach to **3** is shown in Scheme 1. From **4**, compound **5** was prepared according to a modification of the reported method.<sup>4</sup> The oxetane ring was opened by the benzenethiolate anion to generate the sulphide-alcohol **6**. Mesylation of the hydroxy function of **6**, followed by treatment with diphenylphosphide anion, produced the desired phosphine compound ( $\pm$ )-**3**, after anaerobic chromatography of the crude product on a column of degassed silica gel. This terdentate was characterized by a spectroscopic method and elemental analysis. The  $^{31}P$  NMR spectrum shows a single peak at  $-24.78$  ppm, upfield from the reference of 85%  $H_3PO_4$ , which is the characteristic absorption of a tertiary phosphine.

### Group VI complexes

The group VI carbonyl complexes, (PSO)M(CO)<sub>4</sub>, in which M = Cr (**8a**), Mo (**8b**) and W (**8c**), were readily prepared by means of the direct ligand substitution reaction. The complexes **8a-8c** were made by the thermal reaction of **3** with the corresponding M(CO)<sub>6</sub> in boiling, degassed xylene. Attempts to prepare (PSO)Mo(CO)<sub>3</sub> failed. The substitution reaction of Mo( $\eta^6$ -cycloheptatriene)(CO)<sub>3</sub> by PSO led to the isolation of **8b** instead

\* Author to whom correspondence should be addressed.

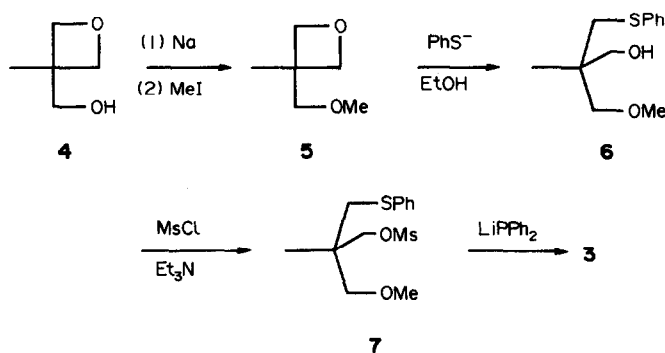

Scheme 1.

of (PSO)Mo(CO)<sub>3</sub>. Other thermal substitution reactions or photochemical activation of **8b** were unable to force the oxygen donor to become coordinated. All purified tetracarbonyl metal complexes have been identified by both spectroscopic and elemental analyses; their data are summarized in Table 1.

Crystals of **8a** and **8c** were grown from hexane and dichloromethane solvents and are isomorphous. The structure of **8a** shows the chromium centre to have an octahedral stereochemistry with four carbonyls, and the phosphorus and the sulphur donors of PSO bound to the metal (Figs 1 and

2). All bond distances and bond angles are within normal ranges; some selected bond distances and bond angles are given in Table 2. The M—C distances for both **8a** and **8c** *trans* to phosphorus are longer than those *trans* to sulphur; this effect is believed to be a consequence of the presence of metal-to-sulphur  $\pi$ -back-donation.<sup>2,4</sup>

#### Manganese(I) complexes

From the reaction of equimolar **3** and Mn(CO)<sub>5</sub>Br in boiling chloroform, a yellow crystalline solid of complex **9** was isolated. The IR spectrum

Table 1. Spectroscopic and analytical data of complexes **8a–8c**

Complex	<sup>1</sup> H NMR	<sup>31</sup> P NMR ( $\Delta_{\delta P}$ ) <sup>a</sup>	IR [ $\nu(\text{CO})$ ] (cm <sup>-1</sup> )	Analysis
<b>8a</b>	7.56–7.34 (m, 15 H), 3.05 (s, 3 H) 2.82–3.09 (m, 4 H) 2.63 (dd, $J = 24.6$ , $J_{\text{P-C-H}} = 8$ Hz, 1 H) 2.35 (dd, $J = 24.6$ , $J_{\text{P-C-H}} = 8$ Hz, 1 H) 0.86 (s, 3 H)	37.36 (62.1)	2008 1960 1912 1885	C <sub>28</sub> H <sub>27</sub> OPSCr Calc. C, 60.2; H, 4.9 Found C, 60.1; H, 5.1
<b>8b</b>	7.62–7.35 (m, 15 H), 3.12 (s, 3 H) 3.18 (d, $J = 10.8$ Hz, 1 H) 3.02 (d, $J = 10.8$ Hz, 1 H) 3.02 (d, $J = 9.4$ Hz, 1 H) 2.94 (d, $J = 9.4$ Hz, 1 H) 2.67 (dd, $J = 15$ , $J_{\text{P-C-H}} = 7$ Hz, 1 H) 2.47 (dd, $J = 15$ , $J_{\text{P-C-H}} = 7$ Hz, 1 H) 0.95 (s, 3 H)	18.51 (43.3)	2019 1976 1916 1891	C <sub>28</sub> H <sub>27</sub> OPSMo Calc. C, 55.8; H, 4.5 Found C, 56.2; H, 4.5
<b>8c</b>	7.70–7.32 (m, 15 H), 3.13 (s, 3 H) 3.30 (d, $J = 11.4$ Hz, 1 H) 3.16 (d, $J = 11.4$ Hz, 1 H) 3.01 (d, $J = 5.8$ Hz, 1 H) 2.94 (d, $J = 5.8$ Hz, 1 H) 2.80 (dd, $J = 14.6$ , $J_{\text{P-C-H}} = 8$ Hz, 1 H) 2.60 (dd, $J = 14.6$ , $J_{\text{P-C-H}} = 8$ Hz, 1 H) 0.97 (s, 3 H)	3.36 (28.1)	2014 1929 1910 1883	C <sub>28</sub> H <sub>27</sub> OPSW Calc. C, 48.7; H, 3.9 Found C, 49.5; H, 4.0

<sup>a</sup> Coordination chemical shifts ( $\Delta_{\delta P}$ ) =  $\delta_p(\text{complex}) - \delta_p(\text{free ligand})$ , in ppm.

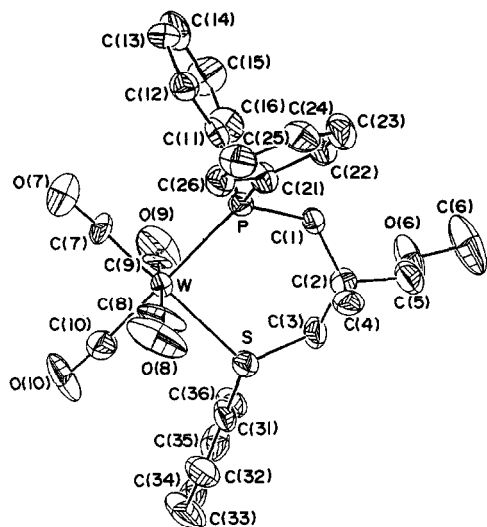
 Fig. 1. The ORTEP drawing of **8c**.

( $\nu(\text{CO}) = 2034, 1961, 1907 \text{ cm}^{-1}$ ) of **9** shows three terminal CO stretches in *fac*-geometry.<sup>5</sup> Both  $^{31}\text{P}$  and  $^1\text{H}$  NMR spectra indicate that phosphorus and sulphur donors bind to the metal centre with the oxygen site uncoordinated. This evidence indicates the structure of **9** to be an octahedral complex with phosphorus, sulphur and bromide in a *fac*-arrangement.

Another way to achieve complex **9** is by the reaction of **3** and  $\text{Mn}_2(\text{CO})_{10}$  to generate  $[(\text{PSO})\text{Mn}(\text{CO})_3]_2$  (**10**), followed by treatment with bromine (Scheme 2). It is interesting to note that both IR and  $^1\text{H}$  NMR spectra of **10** are similar to those of **9**; only the  $^{31}\text{P}$  chemical shifts for both complexes have a slight difference ( $\delta$  25.66 of **9** vs  $\delta$  27.63 of **10**). However, we have not determined the exact structure of **10**.

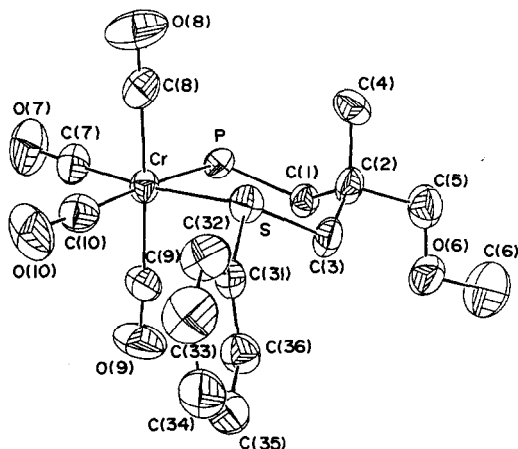
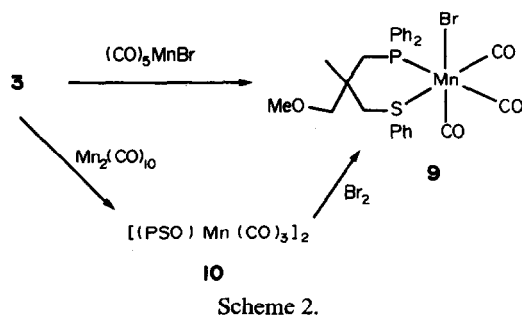
 Fig. 2. The ORTEP drawing of **8a** (phenyl groups omitted for clear view).

Scheme 2.

### Palladium(II) complex

The reaction of equimolar amounts of **3** and  $\text{PdCl}_2$  in acetonitrile afforded the desired complex  $(\text{PSO})\text{PdCl}_2$  (**11**) as a yellow, crystalline solid upon recrystallization. Both  $^1\text{H}$  and  $^{31}\text{P}$  NMR spectroscopic data of the compound indicate that the potentially terdentate PSO ligand acts in a bidentate mode with phosphorus and sulphur atoms binding to palladium metal in a *cis*-fashion. This structure has been further determined by the single-crystal X-ray diffraction method. Figure 3 shows an ORTEP view of the complex with all non-hydrogen atoms labelled. The coordination geometry around palladium is a square-planar arrangement with the palladium atom slightly  $[0.197(4) \text{ \AA}]$  out of the plane defined by S,P,C(1),C(2). Selected bond dis-

 Table 2. Selected bond distances ( $\text{\AA}$ ) and bond angles ( $^\circ$ ) of complexes **8a**, **8c** and **11**

	<b>8a</b> M = Cr	<b>8c</b> M = W	<b>11</b> M = Pd
M—P	2.385(2)	2.510(3)	2.235(2)
M—S	2.420(2)	2.546(4)	2.285(2)
M—C(7)	1.806(6)	1.88(1)	
M—C(8)	1.911(7)	2.07(1)	
M—C(9)	1.879(6)	1.82(2)	
M—C(10)	1.820(6)	1.94(1)	
M—C(11)			2.289(2)
M—C(12)			2.381(2)
P—C(1)	1.820(5)	1.82(1)	1.830(6)
S—C(3)	1.822(6)	1.81(1)	1.824(7)
C(1)—C(2)	1.549(9)	1.54(2)	1.524(7)
C(2)—C(3)	1.538(8)	1.56(2)	1.518(9)
S—M—P	91.85(7)	89.7(1)	97.81(6)
P—M—C(7)	88.8(2)	89.8(4)	
S—M—C(10)	92.0(2)	91.2(4)	
C(7)—M—C(10)	87.8(3)	89.8(6)	
C(8)—M—C(9)	174.7(3)	175.6(5)	
P—M—C(11)			86.26(7)
S—M—C(2)			84.77(7)
C(11)—M—C(12)			91.15(7)

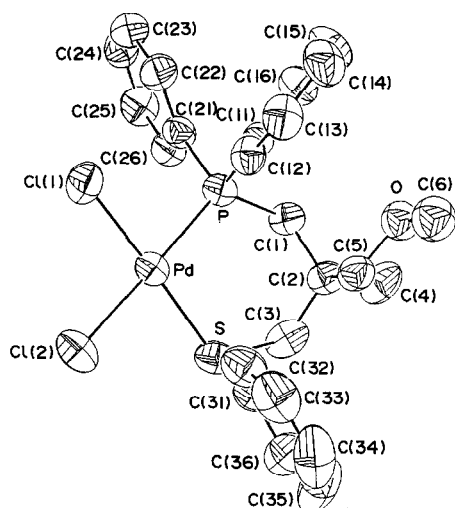

Fig. 3. ORTEP drawing of complex 11.

tances and angles are listed in Table 2. The Pd—Cl bond *trans* to the phosphorus atom is longer, as expected, than that *trans* to the sulphur atom, probably due to the “*trans* effect”.

### Conformational analysis

Table 3 presents all torsional angles around the six-membered chelate rings of the complexes, which also facilitates their comparison. The characteristic  $+g$ ,  $-g$  alternations indicate the conformations of the six-membered chelate rings of **8a**, **8c** and **11** to be in chair forms, which are considered the most stable.<sup>6,7</sup> However, these chair conformations are all slightly distorted, especially in the palladium complex (Fig. 3).

In the previous investigation,<sup>1a,1b</sup> we found that the conformations of  $(P_2S)Mo(CO)_4$  and  $(P_2O)Cr(CO)_4$  were in twist-boat forms mainly due to the steric interactions of substituents along the chelate

Table 3. Torsional angles ( $^\circ$ ) around the six-membered chelate rings of complexes **8a**, **8c** and **11**

	<b>8a</b> M = Cr	<b>8c</b> M = W	<b>11</b> M = Pd
M—P—C(1)—C(2)	-52.5(3)	-54.1(7)	43.5(3)
P—C(1)—C(2)—C(3)	80.3(4)	81.8(10)	-71.9(4)
C(1)—C(2)—C(3)—S	-81.1(4)	-82.4(10)	67.0(4)
C(2)—C(3)—S—M	57.7(3)	57.6(6)	-34.9(3)
C(3)—S—M—P	-28.8(2)	-28.9(4)	6.4(2)
S—M—P—C(1)	25.4(2)	26.0(4)	-9.9(2)

ate rings, as shown in Fig. 4(a). Apparently, the trivalent thioether (coordination to the metal) helps to relieve some 1,3-diaxial interactions in the chelate rings of complexes **8a** and **8c**, so that the chelate rings are able to adopt chair forms [Fig. 4(b)].

In contrast to an equatorial position, the phenyl group attached to the sulphur atom is situated in an axial position in the palladium complex **11**. This difference obviously suggests the “eclipsed” interaction of the equatorial phenyl group and the chloride ligand to be larger than the 1,3-diaxial interaction. Of course, another factor contributing to this outcome is that the larger angle of S—Pd—P [ $97.81(6)^\circ$ ] increases the distance between phosphorus and sulphur, which leads to the decrease of the 1,3-diaxial interaction between the phenyl groups.

The resolution of the chiral ligand PSO and its applications are currently in progress.

### EXPERIMENTAL

The general information has been described in detail previously.<sup>1</sup> Compound **4** was prepared according to the reported method.<sup>8</sup>

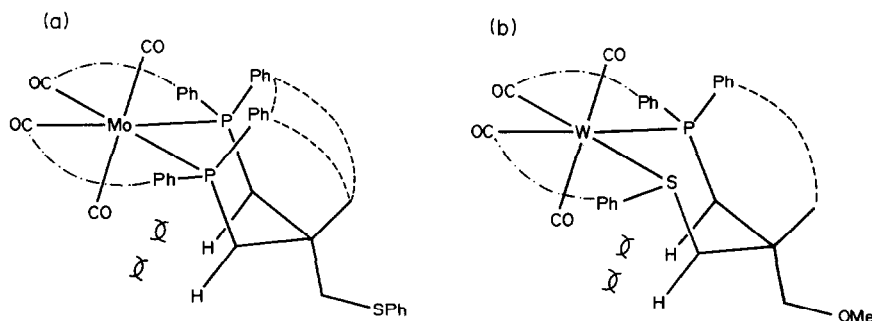

Fig. 4. (a) Three types of major steric interactions of  $(P_2S)Mo(CO)_4$  in the chair conformation: (i) 1,3-diaxial interactions (---); (ii) “eclipsed” interactions between apical ligands (CO) and phenyl groups (-·-·-); (iii) interactions between apical ligands and axial hydrogen atoms (X). (b) The steric interaction of  $(PSO)W(CO)_4$  in the chair form.

**3-Methoxymethyl-3-methyloxetane (5)**

Freshly-cut sodium metal (3.7 g) was added to a solution of **4** (16.27 g, 0.16 mol) in toluene (40 cm<sup>3</sup>). The mixture was heated to reflux overnight. Iodomethane (12 cm<sup>3</sup>, 0.16 mol) was added to the above solution, which was then stirred at room temperature for 36 h. The reaction mixture was quenched with water (50 cm<sup>3</sup>) and the organic layer was separated. The organic portion was extracted with ether (20 cm<sup>3</sup> × 3). All organic extracts were combined, dried and concentrated. The residue was distilled to give compound **5** (10.0 g, 54%) as a clear liquid: b.p. 138–142°C/760 mm (similar to literature<sup>9</sup>).

**2-Hydroxymethyl-2-phenylthiomethyl-1-methoxypropane (6)**

Freshly-cut sodium metal (4.15 g, 180.4 mmol) was added to ethanol (70 cm<sup>3</sup>) under a nitrogen atmosphere. After all the sodium had reacted, thiophenol (18 cm<sup>3</sup>, 175.3 mmol) was added to the ethoxide solution slowly, this was then stirred for 30 min. Compound **5** (6.63 g, 57.2 mmol) was transferred into the above solution and the resulting mixture was heated to reflux overnight. Water (20 cm<sup>3</sup>) followed by ether (40 cm<sup>3</sup>) was added to the reaction mixture. The organic layer was separated, and the aqueous layer was extracted with ether

(30 cm<sup>3</sup> × 2). The combined organic extracts were dried and concentrated. The residue was chromatographed on silica (100 g) with elution by 5% ethyl acetate in hexane. The desired compound **6** was obtained as a viscous, yellow liquid (8.08 g, 62%). <sup>1</sup>H NMR: δ 7.40–7.00 (m, 5 H), 3.48 (d, *J* = 9 Hz, 1 H), 3.42 (d, *J* = 9 Hz, 1 H), 3.20 (d, *J* = 3 Hz, 2H), 3.15 (s, 3 H), 3.08 (d, *J* = 9 Hz, 1 H), 2.92 (d, *J* = 9 Hz, 1 H), 2.70 (br, 1 H), 0.80 (s, 3 H). Found: C, 63.1; H, 8.1. Calc. for C<sub>12</sub>H<sub>18</sub>O<sub>2</sub>S: C, 63.7; H, 8.1%.

**2-Diphenylphosphinomethyl-2-phenylthio-1-methoxypropane (3)**

The hydroxy compound **6** was transformed into mesylate **7** according to a standard procedure described previously.<sup>1b</sup> To a solution of diphenylphosphine (3.23 g, 17.2 mmol) in THF (100 cm<sup>3</sup>) was added a 2.50 M hexane solution of *n*-butyllithium (17.0 cm<sup>3</sup>) at ice-cooled temperature. After stirring for 30 min, compound **7** (4.24 g, 13.9 mmol), in a small portion of THF, was added to the phosphide anion solution. The resulting mixture was heated to reflux for 4 h; degassed water (10 cm<sup>3</sup>) was then added. The organic layer was separated, dried and concentrated. The crude product was chromatographed on silica (100 g) with elution by 40% ethyl acetate in hexane. The desired tripodal ligand, PSO, was obtained as a viscous, colourless

Table 4. Summary of crystal data of complexes **8a**, **8c** and **11**

	<b>8a</b>	<b>8c</b>	<b>11</b>
Formula	CrPSC <sub>28</sub> H <sub>27</sub> O <sub>5</sub>	WPSC <sub>28</sub> H <sub>27</sub> O <sub>5</sub>	PdPSC <sub>24</sub> H <sub>23</sub> Cl <sub>2</sub> O
Crystal size (mm)	0.7 × 0.7 × 0.5	0.6 × 0.6 × 0.5	0.5 × 0.5 × 0.5
Lattice	Orthorhombic	Orthorhombic	Orthorhombic
Space group	<i>Pna</i> 2 <sub>1</sub>	<i>Pna</i> 2 <sub>1</sub>	<i>Pbca</i>
<i>a</i> (Å)	16.786(8)	16.896(8)	16.223(3)
<i>b</i> (Å)	12.728(9)	12.768(4)	15.447(3)
<i>c</i> (Å)	12.754(4)	12.837(5)	19.737(3)
<i>V</i> (Å <sup>3</sup> )	2725.1	2769.3	4945.7
<i>Z</i>	4	4	8
<i>F</i> (000)	1088	1240	2064
Temperature (K)	300	300	300
$\mu$ (mm <sup>-1</sup> )	0.57	4.42	1.11
Transmission	0.94–1.0	0.65–1.0	0.85–1.0
2 $\theta$ <sub>max</sub>	54	55	50
<i>h</i> , <i>k</i> , <i>l</i>	21, 16, 16	21, 16, 16	19, 18, 23
$\lambda$ (Å)	0.7093	0.7093	0.7093
Number of reflections	3097	3318	4350
Number of observed reflections	2208 (> 2.5 $\sigma$ )	2477 (> 2.0 $\sigma$ )	2682 (> 2.5 $\sigma$ )
Number of variables	325	325	270
<i>R</i> ( <i>F</i> )	0.045	0.040	0.037
<i>R</i> <sub>w</sub> ( <i>F</i> )	0.034	0.037	0.037
<i>S</i>	2.42	3.81	2.87

liquid. <sup>1</sup>H NMR: δ 7.60–7.00 (m, 15 H), 3.10 (s, 2 H), 3.00 (s, 3 H), 2.90 (s, 2 H), 2.20 (d, *J*<sub>P–C–H</sub> = 3 Hz, 2 H), 0.90 (s, 3 H). Found: C, 73.1; H, 7.0. Calc. for C<sub>24</sub>H<sub>27</sub>OPS: C, 73.1; H, 6.9%.

#### Preparation of 8a–8c

The ligand PSO and an equimolar amount of group VI metal carbonyl (M(CO)<sub>6</sub>, M = Cr, Mo and W) were dissolved in an aromatic solvent (toluene or xylene) and heated to reflux for 8–10 h. The desired complexes were isolated by chromatography on silica. All spectroscopic and analytic data are given in Table 1.

#### Preparation of (PSO)Mn(CO)<sub>3</sub>Br (9)

A solution of BrMn(CO)<sub>5</sub> (45.7 mg, 0.17 mmol) and PSO (65.5 mg, 0.17 mmol) in chloroform was refluxed for 30 min. After addition of hexane, the solution was allowed to stand for several days. The complex *fac*-(PSO)Mn(CO)<sub>3</sub>Br was crystallized as yellowish needles (65.3 mg, 64%). IR: ν(C=O) 2034, 1961, 1907 cm<sup>-1</sup>. <sup>1</sup>H NMR: δ 7.90–7.30 (m, 15 H), 3.25 (s, 3 H), 3.09 (d, *J* = 8.84 Hz, 1 H), 3.03 (d, *J* = 8.84 Hz, 1 H), 2.71 (d, *J* = 11 Hz, 1 H), 2.64 (d, *J* = 11 Hz, 1 H), 2.44 (dd, *J* = 10, 15.3 Hz, 1 H), 2.15 (dd, *J* = 10, 15.3 Hz, 1 H), 0.61 (s, 3H). <sup>31</sup>P NMR: δ 25.66. Found: C, 48.7; H, 4.0. Calc. for C<sub>27</sub>H<sub>27</sub>O<sub>4</sub>PSMnBr: C, 49.1; H, 4.1%.

#### Preparation of (PSO)PdCl<sub>2</sub> (11)

This complex was obtained as a yellow, crystalline solid by stirring a mixture of PSO and PdCl<sub>2</sub> in acetonitrile, followed by recrystallization from dichloromethane and ethyl acetate, m.p. (dec.) 190°C. <sup>1</sup>H NMR: δ 7.94–7.30 (m, 15 H), 3.03 (s, 3 H), 2.97 (d, *J* = 5 Hz, 1 H), 2.95 (d, *J* = 5 Hz, 1 H), 2.89 (d, *J* = 2.7 Hz, 1 H), 2.87 (d, *J* = 2.7 Hz, 1 H), 2.49 (dd, *J* = 22.5, 12 Hz, 1 H), 2.09 (dd, *J* = 22.5, 12 Hz, 1 H), 0.93 (s, 3 H). <sup>31</sup>P NMR: δ 17.81.

Found: C, 50.1; H, 4.7. Calc. for C<sub>24</sub>H<sub>27</sub>OPSPdCl<sub>2</sub>: C, 50.4; H, 4.8%.

#### Crystallographic analysis of complexes 8a, 8c and 11

Cell parameters were determined on a CAD-4 diffractometer by a least-squares treatment. Atomic scattering factors were taken from the *International Tables for X-ray Crystallography*.<sup>10</sup> *Computations* was carried out by using the *NRCC SDP VAX* package.<sup>11</sup> Relevant data are summarized in Table 4.

*Acknowledgement*—Financial support from the National Science Council (R.O.C.) is acknowledged.

## REFERENCES

- (a) S.-T. Liu, H.-E. Wang, M.-C. Cheng and S.-M. Peng, *J. Organomet. Chem.* 1989, **376**, 333; (b) S.-T. Liu, G.-J. Liu, C.-H. Yieh, M.-C. Cheng and S.-M. Peng, *J. Organomet. Chem.* 1990, **387**, 83; (c) S.-T. Liu, C.-H. Yieh and H.-J. Lu, *Phosphorus, Sulfur and Silicon* 1989, **44**, 261.
- S. G. Murray and F. R. Hartley, *Chem. Rev.* 1981, **81**, 365 and refs therein.
- For recent review in tripodal polyphosphines see: L. Sacconi and F. Mani, in *Transition Metal Chemistry* (Edited by G. A. Melson and B. N. Figgis), Vol. 8, p. 179. Marcel Dekker, New York (1982).
- M. F. Lappert, D. B. Shaw and G. M. McLaughlin, *J. Chem. Soc., Dalton Trans.* 1979, 427.
- C. S. Kraihanzel, J. M. Ressler and G. M. Gray, *Inorg. Chem.* 1982, **21**, 879.
- J. R. Gollongly and C. J. Hawkins, *Inorg. Chem.* 1972, **11**, 156.
- M. R. Churchill, A. L. Rheingold and R. L. Keiter, *Inorg. Chem.* 1981, **20**, 2730.
- D. B. Pattison, *J. Am. Chem. Soc.* 1957, **79**, 3455.
- A. J. McAlees, R. McCrindle and A. R. Woon-Fat, *Inorg. Chem.* 1976, **15**, 1065.
- International Tables for X-ray Crystallography*, Vol. IV. Kynoch Press, Birmingham (1974).
- E. J. Gabe and F. L. Lee, *Acta Cryst.* 1981, **A37**, S339.