

# Optimizing the reservoir operating rule curves by genetic algorithms

Fi-John Chang,<sup>1\*</sup> Li Chen<sup>2</sup> and Li-Chiu Chang<sup>1</sup>

<sup>1</sup> Department of Bioenvironmental Systems Engineering and Hydrotech Research Institute, National Taiwan University, Taipei, Taiwan

<sup>2</sup> Department of Civil Engineering, Chung-Hua University, Hsin-Chu, Taiwan

---

## Abstract:

Genetic algorithms, founded upon the principle of evolution, are applicable to many optimization problems, especially popular for solving parameter optimization problems. Reservoir operating rule curves are the most common way for guiding and managing the reservoir operation. These rule curves traditionally are derived through intensive simulation techniques. The main aim of this study is to investigate the efficiency and effectiveness of two genetic algorithms (GAs), i.e., binary coded and real coded, to derive multipurpose reservoir operating rule curves. The curves are assumed to be piecewise linear functions where the coordinates of their inflection points are the unknowns and we want to optimize system performance. The applicability and effectiveness of the proposed methods are tested on the operation of the Shih-Men reservoir in Taiwan. The current M-5 operating curves of the Shih-Men reservoir are also evaluated. The results show that the GAs provide an adequate, effective and robust way for searching the rule curves. Both sets of operating rule curves obtained from GAs have better performance, in terms of water release deficit and hydropower, than the current M-5 operating rule curves, while the real-coded GA is more efficient than the binary-coded GA. Copyright © 2005 John Wiley & Sons, Ltd.

KEY WORDS water resource management; operating rule curves; genetic algorithms; binary and real coded

## INTRODUCTION

With high mountains and steep channels all over Taiwan island, most of the rainfall flows immediately into the ocean and approximately 80% of the rainfall amount is concentrated in the wet period from May to October. Consequently, water resources are not always sufficient. A water shortage can occur more than six months of the year. Rapid increases in population and economic growth further accelerate the pressure on the water supply. The efforts to pursue integrated optimal management to achieve sustainable uses of the water resource become critical. Due to the temporal and spatial variability in rainfall and geographic characteristics, water reservoirs are the most effective means for water supply and for mitigating natural disasters such as flooding or drought.

Reservoir operating rules are intended to guide and manage the reservoir system so that the release made is in the best interests of the system objectives, consistent with certain inflow and existing storage levels. All the reservoir systems in Taiwan are still managed on fixed predefined rules, despite the many recent studies that indicate the potential for the use of optimization models, e.g., linear programming and dynamic programming in real-time reservoir operation (Chang and Chang, 2001; Chang *et al.*, 2002). This is mainly due to institutional, rather than technological, limitations. The reservoir operating rules are often predefined in the design stages through simulation techniques, which can be very time-consuming and not always lead to interesting results. Good operating rules that increase the system performance for water supply and energy

---

\* Correspondence to: Fi-John Chang, Dept. of Bioenv Systems Engineering, National Taiwan University, 1 Sec 4 Roosevelt Road, Taipei, Taiwan, 10617 ROC. E-mail: changfi@ntu.edu.tw

production, and decrease undesired deviation from release target, are very beneficial. Consequently, finding effective operating rules is vitally important.

Many analytic and numerical optimization techniques have been developed (Gill *et al.*, 1981; Davis, 1991; Pardalos and Resende, 2002). However, a great number of functions, such as discontinuous, non-convex, no differentiable or multimode, are beyond the capability of analytical methods and present profound difficulties for numerical techniques. Thus, new and more robust optimization techniques, capable of handling complex problems, are needed. Genetic algorithms represent an efficient and robust search method for non-linear optimization problems; this method has been quite successfully applied to optimization problems, such as scheduling (Correa *et al.*, 1999), adaptive control (Booker, 1982), transportation problems, database query optimization (Bennett *et al.*, 1991), water resources management and planning (Oliveira and Loucks, 1997; Simpson *et al.*, 1994), etc. In this paper, two genetic algorithms (GAs)—binary and real coded—are introduced and implemented to identify operating rule curves of the Shih-Men reservoir, Taiwan.

### GENETIC ALGORITHMS

Genetic algorithms are search and optimization techniques based on the principles of natural selection and genetics. They are efficient, adaptive and robust search processes, producing near-optimal solutions. The parallel nature of GAs has also long been recognized, and many have successfully used parallel GAs to reduce the time required to reach acceptable solutions to complex problems (Canfu-Paz, 2000). The primary monograph on the topic is Holland's adaptation in natural and artificial systems in 1975. Since then interest has increased markedly. Simplicity of operation and power of effect are two of the main attractions of the GA approach. GAs are now finding widespread application in scientific, business and engineering circles (Goldberg, 1994). In the water resources field, Goldberg and Kuo (1987) were the first to apply GAs to solve a pipeline optimization problem. Wang (1991) used a GA to calibrate conceptual rainfall-runoff models. Esat and Hall (1994) applied a GA to the four-reservoir problem, suggesting that GAs have potential in water resources optimization and significant savings in computer memory and execution times. Olivera and Loucks (1997) used GAs to develop operating policies for multi-reservoir systems. Chang and Chen (1998) applied a real-coded GA for rule-based flood control reservoir management. A brief review of GA applications to the water resource problem can be found in the work of Wardlaw and Sharif (1999). Sharif and Wardlaw (2000) applied GAs for multi-reservoir systems and concluded that the GAs appear to be robust and satisfactory. Chang and Chang (2001) used GAs to search the optimal reservoir operating schedule, and show that this has produced superior results to the traditional method. Recently, Chang *et al.* (2003) demonstrated that the optimization of rule curves through GA is effective for flushing schedules in a reservoir.

GAs act as a biological inspiration that tends to mimic some of the processes observed in natural evolution, where stronger individuals are usually the winners in a competitive environment. To evaluate the suitability of the derived solution, a suitable objective function is required. The best part of GAs is that they can handle any type of objective function. The objective function is chosen in such a way that highly fitted strings (solutions) have high fitness values. The evolution starts from a set of coded solutions (biologically referred to as chromosomes) and proceeds from generation to generation through genetic operations, i.e., reproduction, crossover and mutation. Through the GA, an optimal solution can be found and represented by the final winner of the process.

In general, candidate solutions can be represented by two different coded methods, namely binary coded and real coded. The binary representation is the most famous and traditional genetic algorithm, while the real coded seems to be on the rise. Since both coding methods have their advantages and drawbacks, in this study we wish to provide our experience and results by using these two GAs for optimizing the rule curves in a multipurpose reservoir. Let us briefly describe the major procedure of these two genetic algorithms, binary and real coded, as follows.

### Binary-coded GA

The common method of applying a GA to real-parameter problems is to encode each parameter as a bit string by using a binary coding, because of its simplicity and tractability. The parameters are joined together as a single binary string (or 'chromosome') of fixed length. For example, we wish to maximize a function of two variables,  $f(x_1, x_2)$ , with ranges,  $a_i \leq x_i \leq b_i$ ,  $i = 1, 2$ . Suppose the required precision is three decimal places for both variables' values. The precision requirement implies that the range  $[a_i, b_i]$  should be divided into  $(b_i - a_i) \times 10^3$  equal size ranges, and  $m_i$  would be the smallest integer to meet  $(b_i - a_i) \times 10^3 \leq 2^{m_i} - 1$ . Then, each variable  $x_i$  can be represented as a single binary string of length  $m_i$ . The following formula explains each such string:

$$x_i = a_i + \underbrace{\text{decimal}(1001 \dots 101_2)}_{m_i} \times \frac{b_i - a_i}{2^{m_i} - 1}$$

where  $\text{decimal}(\text{string}_2)$  is the decimal value of that binary string. In Figure 1a, we illustrate the series of a coded variable  $x$ , with ranges [1,2], by a binary string of length 3. Each chromosome value actually refers to a coded possible solution. A set of such chromosomes in a generation is called a population.

**Reproduction.** The reproduction process copies parent chromosomes into a tentative new population. The probability of selected chromosomes for the next generation is directly proportional to its fitness value. The selection is in accordance with the schema theorem (Goldberg, 1989): the best chromosomes get more copies, the average stay even, and the worst die off. A great number of selection algorithms have been presented in the literature (Michalewicz, 1999). Among them, Roulette Wheel selection is perhaps the most common method, but it frequently makes premature convergence. Tournament selection (Goldberg and Deb, 1991), which combines the idea of ranking in a very interesting and efficient way, is used in our study.

**Crossover.** The crossover recombines two parent chromosomes to produce offspring new chromosomes for the next generation, which includes three steps. First, chromosomes from the mating pool are randomly paired. Then, it is determined whether these pairs should go for crossover or not, based on a preset crossover

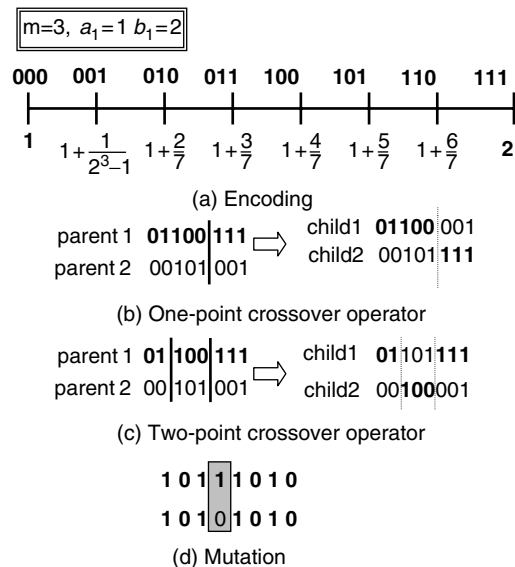

Figure 1. Binary code

probability. Third, chromosome segments between mating pairs are interchanged. The operator can be one-point crossover or multi-point crossover, which is illustrated in Figure 1b or c.

*Mutation.* To sustain genetic diversity in the population, mutation is also made occasionally with small probability. A random position of a random string is selected and replaced by another character from the alphabet; e.g., in the binary coding, this simply means changing a 1 to a 0 and *vice versa* (as shown in Figure 1d).

#### *Real-coded GA*

A growing number of researchers have come to advocate large alphabet real-coded (or floating-point) genes as opposed to small alphabet binary-coded genes (Wright, 1991; Eshelman and Schaffer, 1993; Michalewicz, 1999). This representation is introduced especially to deal with real parameter problems, and it would be faster in computation and more consistent from the basis of run-to-run (Michalewicz, 1999).

According to several previous works, real-coded GAs have advantages over binary-coded GAs (Wright, 1991; Eshelman and Schaffer, 1993; Chang and Chen, 1998) and these are summarized as follows. First, real-coded genes could eliminate inadequate precision of parameters in the search space. Second, for a real-coded GA, the range of a parameter does not have to be a power of 2. Third, GAs operating on real-coded genes have the ability to exploit the gradualness of functions of continuous variables. Gradualness here means that small changes in the variables correspond to small changes in the function.

In real-coded GAs, each chromosome vector is coded as a vector of floating point numbers, of the same length as the solution vector. Figure 2a shows a real coding of 12 variables and each variable is represented by one gene. This is different from binary coding, where a bit is a gene while a variable is represented by  $m$  genes. The precision depends on the underlying machine, but is generally much better than that of the binary representation.

The real-coded GA has quite different mechanisms of crossover and mutation (Michalewicz, 1999). In the following subsections, we briefly illustrate these operators that are used in our study.

*Real-crossover.* Simple crossover operator of the real-coded GA is analogous to that of binary-coded GA (as shown in Figure 2b). This operator frequently makes offspring much worse than their parents when they are both relatively good (Wright, 1991).

Blend crossover (Eshelman and Schaffer, 1993) (BLX- $\alpha$ ) could solve this problem. It randomly picks a point that lies between  $\text{parent1} - \alpha(\text{parent2} - \text{parent1})$  and  $\text{parent2} + \alpha(\text{parent2} - \text{parent1})$  where parent1 and parent2 are the two parent points and  $\text{parent2} > \text{parent1}$  (as shown in Figure 2c). The BLX-0.5 is less likely to prematurely converge from empirical tests (Chang and Chen, 1998).

*Real-mutation.* A mutation operator of the real-coded GA is that specific element of a chromosome that randomly jumps in the search space if it has exactly equal chance of undergoing the mutative process. Figure 2d illustrates an element of a two-dimensional chromosome chosen for mutation, and it randomly jumps from  $(x,y)$  to  $(x^*, y)$ , where  $x$  and  $x^*$  are bound between the lower and upper limit.

## THE RESERVOIR SYSTEM

The Shih-Men reservoir, which was completed in 1964 and has a storage capacity of  $236 \times 10^6 \text{ m}^3$ , is one of the major storage reservoirs in Taiwan. Located in the upper stream of the Tan-Shi river basin as shown in Figure 3, the reservoir is a multipurpose reservoir for flood control, hydroelectric power generation, water supply and recreation. The hydropower plant has a generating capacity of 45 MW. There are four irrigation areas and five public water plants in the water supply system that use the released water from this reservoir (Figure 4).

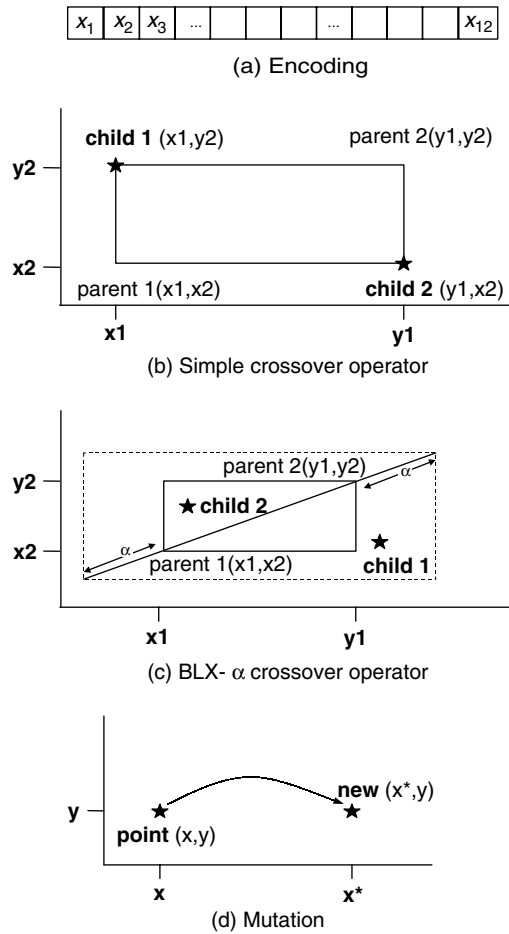

Figure 2. Real code

The M-5 operating rule curve in use was derived by trial-and-error during the reservoir planning period, which was before 1964. Because the demand changes and more than 30 years of hydrological data are observed and added to the system, the existing operating rule curves need to be modified. The operating rule includes three curves: upper limit, lower limit and critical limit (Figure 5). Based on the operating rule curves, the operating policy can be briefly described as follows.

1. When the water level is above the upper limit, the water release for hydropower generation should be increased to keep the water level at the upper limit.
2. When the water level is between the upper and lower limits, the release, including public use, irrigation water supply and hydropower generation, is under normal operating conditions.
3. When the water level is between the lower and critical limits, public use and irrigation water can be supplied as usual, but the water release for hydropower generation must be cut back by 20%.
4. When the water level is below critical limits, irrigation water must be cut back by 30%, and the water release for hydropower generation must be reduced to the magnitude of public use plus irrigation water requirements only.

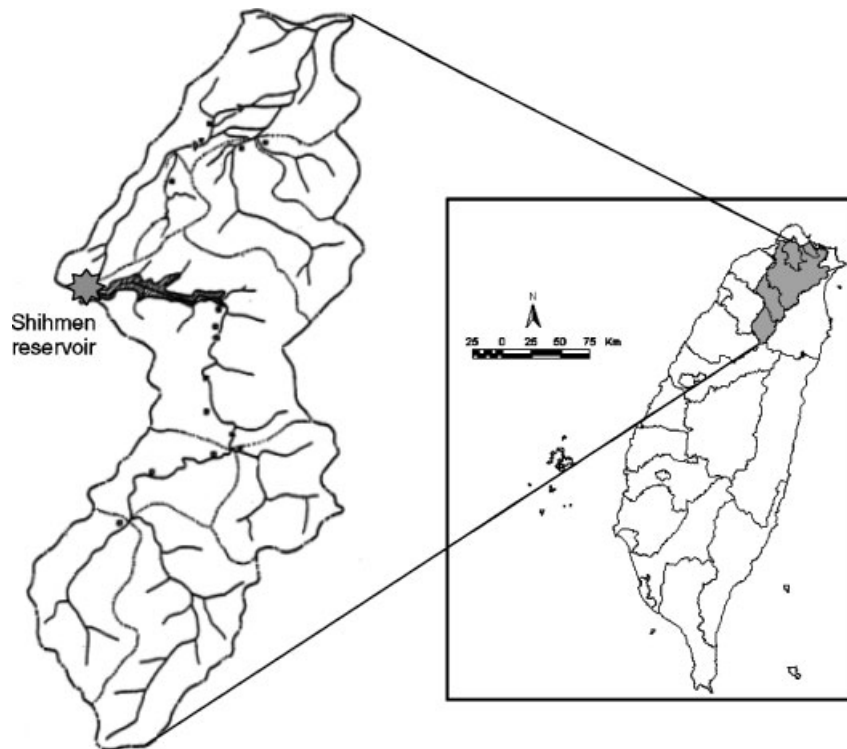

Figure 3. The Shih-Men reservoir and the basin of Tan-Shi River, Taiwan

The operating rule defines the release within each year as a function of the existing storage level and overall release target amounts. The simulation model is designed to calculate the system performance based on a set of processing rule curves. The set of processing rule curves, in terms of 36 inflection points or a chromosome, is generated from GA in its process. The simulation results, such as water release and reservoir stage, are then fed back to GA to calculate its performance for an objective function value. The simulation model and GA are integrated as a calculation mode. A simplified water supply network system of the Shih-Men reservoir is shown in Figure 4. There are three input streamflows, one reservoir and hydropower station, five public waterworks, four irrigation areas, one river dam and 12 merge points.

#### GENETIC ALGORITHMS FOR RULE CURVES OPTIMIZATION

As mentioned above, operating curves (M-5) were obtained several decades ago through a simulation search method. Because the demand has changed significantly and more hydrological data have been collected, it is necessary to re-evaluate the performance of the original M-5 curves and to search a best set of operating curves by using more efficient searching techniques as follows.

The GA for optimizing the rule curves of the Shih-Men reservoir is introduced. As illustrated in Figure 5, the operating rule curves are piecewise linear functions. Searching the coordinates of their inflection points can be thought of as an optimization problem, which is to find the coordinate values that define the rule curves that maximize system performance. This section describes how the procedures are accomplished in this application.

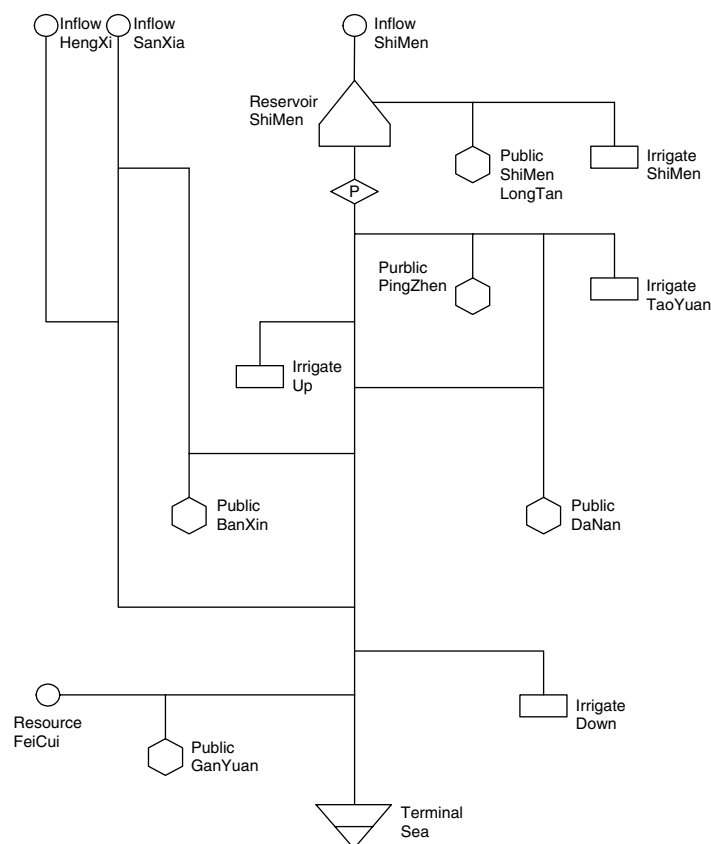

Figure 4. Water supply system of Shih-Men reservoir

#### *Coding the parameter set strings*

GAs require encoding schemes that transform the vector of a variable to a structure that permits genetic operations. Binary strings are the most common encoding schemes, but real strings have become more popular in recent studies. Both methods, i.e., binary coded and real coded, are implemented and their results will be illustrated and compared. There are three curves and each curve has 12 inflection points (12 months), so the total number of inflection points is 36. Using the described encoding scheme, we can define the problem by a set of 36 parameters (the coordinate values of the inflection points), i.e., 12 critical limit, 12 lower limit, 12 upper limit curve inflection points, respectively. One set of constraints requires that the simultaneous coordinate values of upper limit point  $>$  lower limit point  $>$  critical limit point, while all the values must be within the boundary of the minimum admissible storage level, i.e., 195 m, and maximum allowable storage level, i.e., 245 m.

#### *Establishing an objective function and subjective conditions*

An optimization problem should have an objective function and may have several subjective conditions. As mentioned above, the Shih-Men reservoir is a multipurpose reservoir; however, if one looks through the operation policy, it is not hard to realize that the main consideration is water supply for a different purpose. The shortage index (SI) proposed by the US Army Corps of Engineer (HEC, 1975) could represent the lumped water supply shortage and reflect the severity of the water shortage; consequently, it is used as the objective

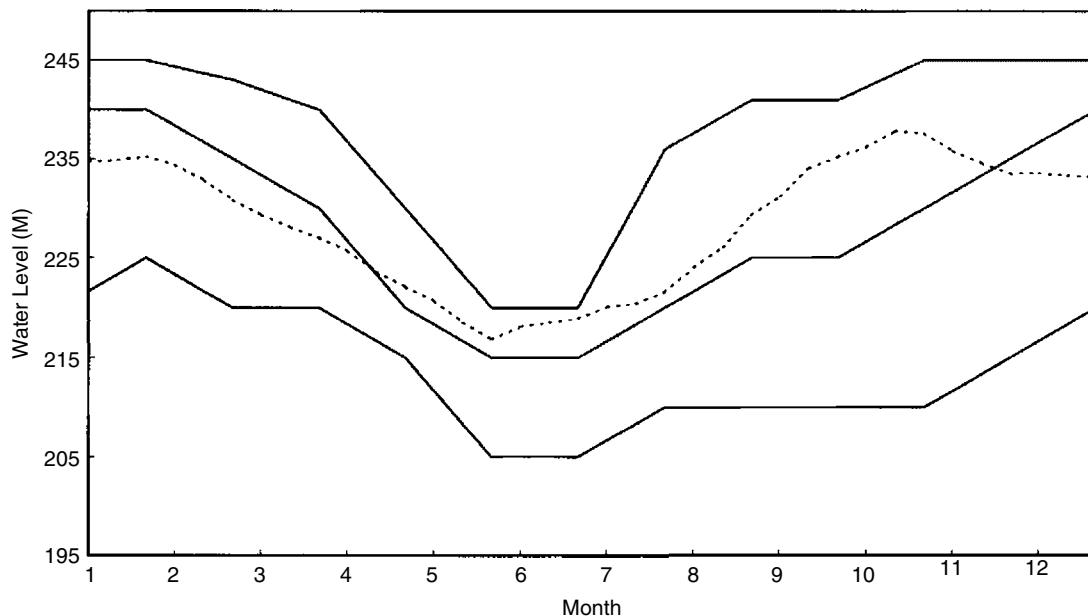

Figure 5. The M-5 rule curves and simulated average water level

function for this study. The SI is defined in the following:

$$SI = \frac{100}{N} \sum_i \left( \frac{\text{Water deficit in the period } i}{\text{Designed water supply for the period } i} \right)^2$$

where  $N$  is the number of periods ( $N = 36 \text{ 10-day} \times \text{number of years}$ , i.e.,  $N = 36 \times 36 = 1296$ ). Two types of constraint for the Shih-Men system are considered: continuity equations and physical conditions. The continuity equations have been set and must be satisfied for all the objects in the system, such as reservoir, river dam, irrigation area, public water or merger point. For example, the continuity equation for the Shi-Men reservoir is  $S_{t+1} = S_t + I_t - R_t$  where  $S$  is the reservoir capacity,  $I$  is the inflow and  $R$  is the water release, and  $t$  is the time step.

The physical constraints include: (1) the water level should be within the effective boundary, e.g., storage dead level 195 m and highest level 245 m; (2) the water requirement for the Shih-Men irrigation channel should be less than  $18.4 \text{ m}^3/\text{s}$  and for the Taoyuan irrigation channel should be less than  $16.8 \text{ m}^3/\text{s}$ ; and (3) the water requirement and water release for each waterworks should be within its designed capacity (Chen, 1995).

#### *Integrating the simulation and optimization models*

The entire procedure of the calculation mode includes two parts: the simulation model and the GA optimization model. Combining these two parts to search for the best set of operating rule curves is a crucial task. As mentioned above, this very complex multipurpose system includes the reservoir itself, river dam, three streamflow inputs, several irrigation areas and published waterworks, one hydropower station and numerous merge points. Moreover, in order to verify the usefulness of the rule curve in the long term, the efficiency of the reservoir operation should be evaluated on the basis of long-term streamflow records. The computing time of each simulation could be long; consequently, it is impractical to run the simulation model for all the possible cases in its feasible domain, and it would be impossible to obtain the best set of rule curves without using an efficient optimization algorithm. The GA provides a feasible way to conquer

a complex system with so many parameter inflection points that need to be adjusted. First, the optimization model, GA, generates a set of rule curves' parameters, 36 points. Then the simulation model, OOP, uses these curves' parameters to perform the reservoir operation and calculate the objective function value, i.e., SI. This circular procedure is executed for all of chromosomes in each generation (Figure 6). After the crossover and mutation are performed, the procedure is propagated to the next generation, unless the system performance reaches stability.

#### Setting the GA's parameters

Values of the GA's parameters must be defined before the algorithm is used. These parameters include the sample-size population and the probabilities of crossover and mutation. Although it is important to determine the best parameter values, and several studies have tried to do so (DeJong, 1975; Grefenstette, 1986; Schaffer *et al.*, 1989), no universal rules have yet been found. In this circumstance, one relies on experience and trial-and-error to find a good set of parameter values. The suggested sets of values that consistently lead to good results in this study are shown in the following: population size = 100, crossover probability = 0.9, mutation

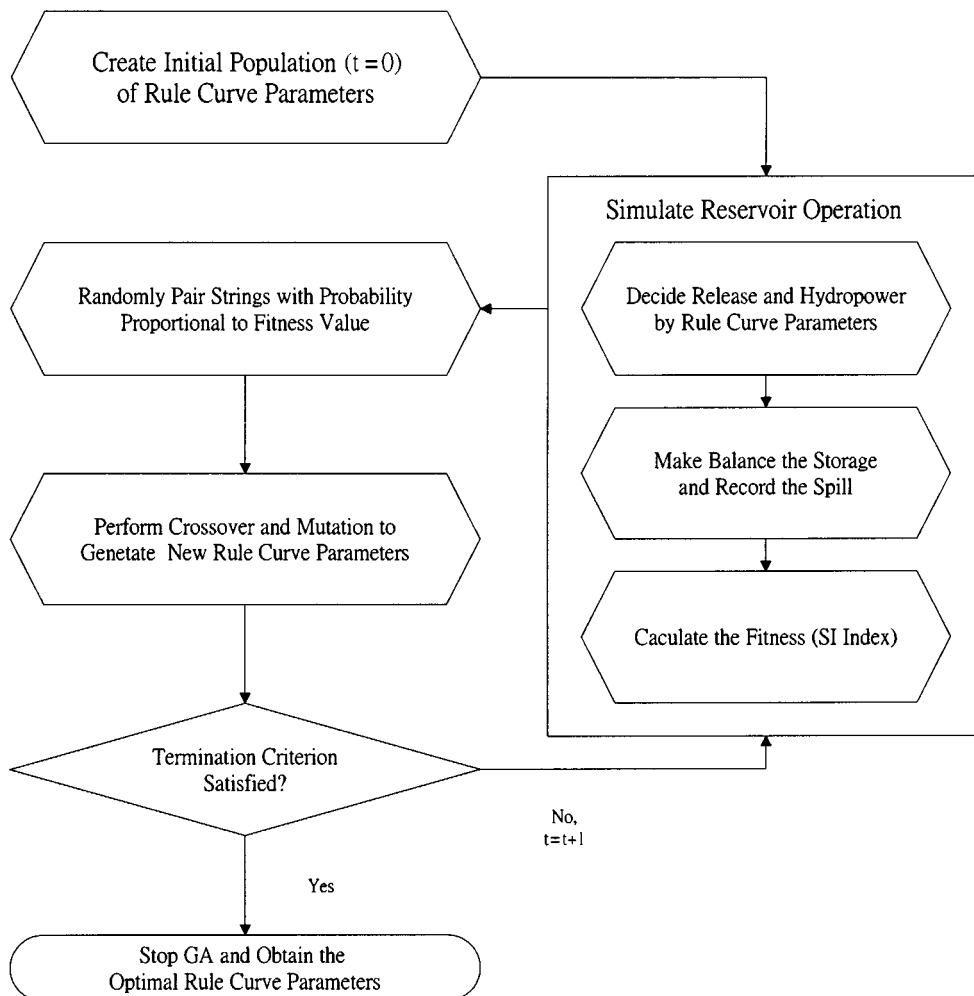

Figure 6. Integration of GA and simulation model

rate = 0.01. For the binary-coded GA, the string length of each variable is set as 3. For the real-coded GA, BLX-0.5 is used to make the crossover.

## RESULTS

To evaluate the long-term reservoir operating performance, the 10-day inflow data, 36 years (1958–1993), i.e., 1296 data records, are used. The water requirement in 1994 is adopted to represent the requirement for the simulation period. The results are shown in Figure 7 and Table I. Figure 7 shows the best objective function values (i.e., SI) in each generation for both real-coded and binary-coded GAs. It appears that after 10 generations, both binary and real-coded GAs closely reach their stable solution, while the real-coded GA has a slightly better performance, in terms of smaller objective function, than the binary-coded GA. The main reason is that we use less precision for a binary-coded GA where the string length of each variable is only set as 3. For a binary-coded GA, it will become inadequate and/or inefficient by using higher precision when a great number of variables are to be estimated. Consequently, only the results obtained from the real-coded GA are depicted and discussed in more detail. Figure 8 represents the best set of operating rule curves obtained from a real-coded GA, and the simulated water level of 36 years and water level of an extreme drought year (1973) are also given. It appears that most of the time, the average water level is within the lower limit and upper limit, which means the water shortage only happened in a few periods. For an extreme drought year (1973), almost all the time, the water level is within the critical and lower limits, and a number of times it is even below the critical limit. This means the water shortage was very serious during 1973. For the purpose of comparison, the M-5 rule curves, i.e., the current operating curves, are used to simulate the reservoir operation based on the same conditions.

Table I shows the shortage index and the average results of 36 years of simulating the reservoir operation according to the GA and M-5 curves, respectively. The shortage index obtained from a long-term reservoir operated by M-5 curves is 15.34 and by GA curves is 8.27, where the shortage index of the GA is only

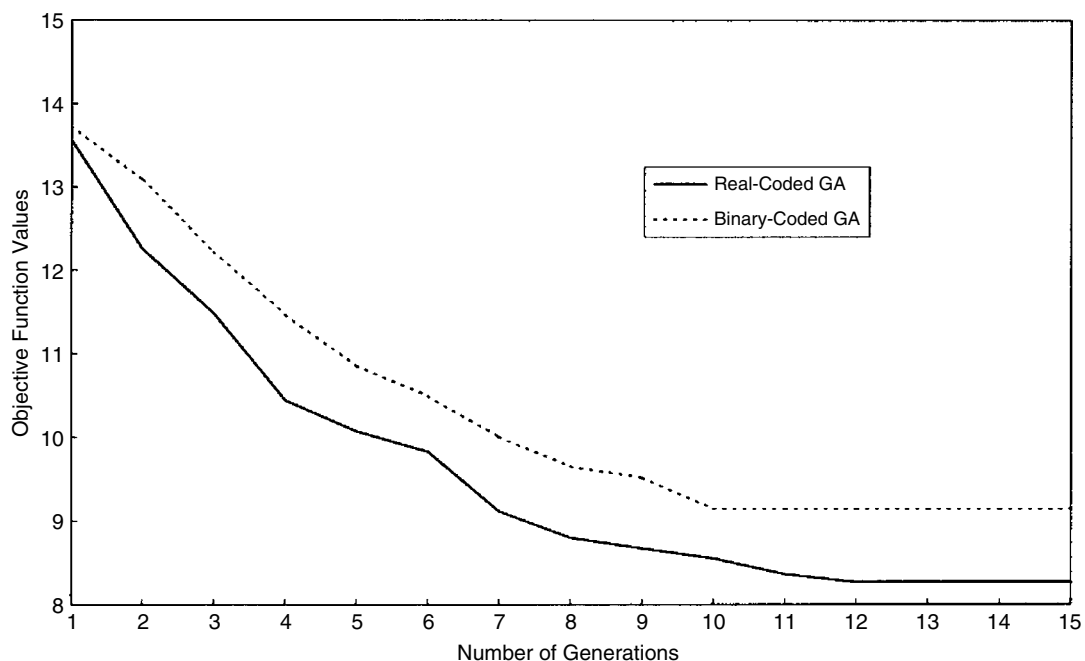

Figure 7. Results of real-coded and binary-coded GAs

Table I. The shortage index and average results from the simulation GA and M-5 operating curves. The averages are based on 36 years simulation

Type of rule curve	Shortage index	Hydropower ( $10^6$ kw-h)	Release ( $m^3/s$ )	Deficit ( $m^3/s$ )	Water resource usage (%)
M-5	15.34	3.19	27.51	1.59	60.3
GA	8.27	3.30	28.39	0.78	62.2

Water resource usage (%) = release/inflow.

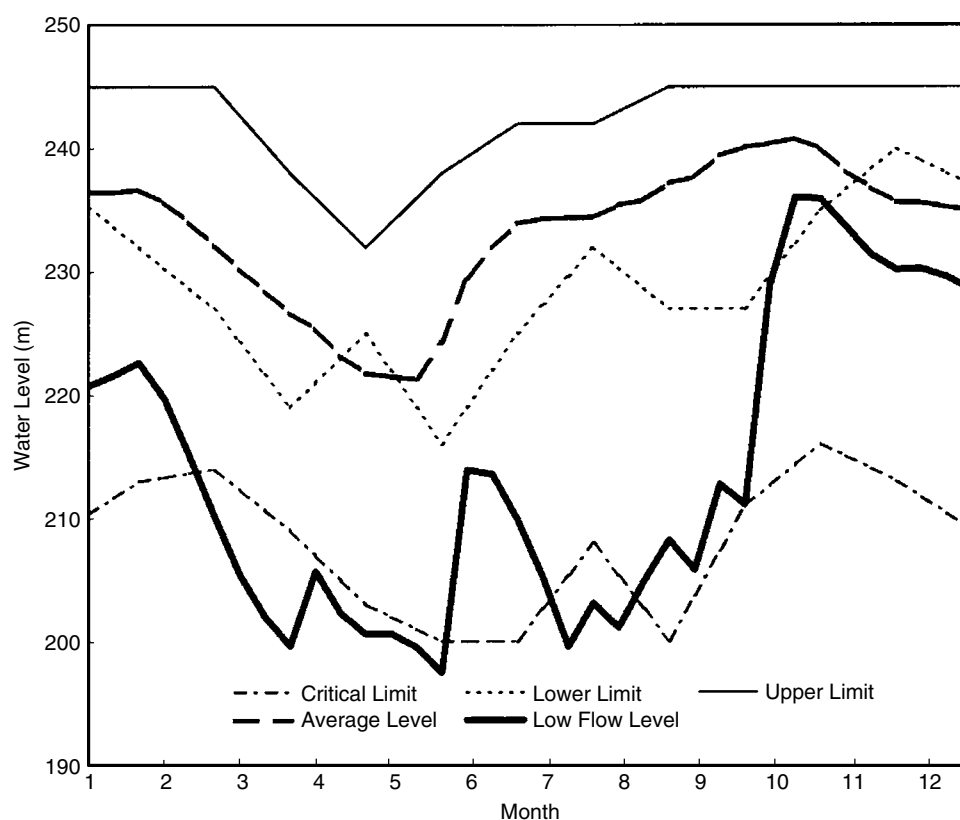

Figure 8. The GA curves and simulated average water levels of 36 years

about half that of M-5. Apparently, the GA curves have a much better performance than the M-5 curves. The results also demonstrate that the set of GA curves have high hydropower and water release, water resource usage and a lower water deficit than the M-5 curves. Undoubtedly, the GA curves have better performance than the currently used M-5 curves in all aspects.

An extreme drought case is further investigated to demonstrate the robustness of the GA curves. The year of 1973 is the most severe drought year during the recorded period of 1958–1993, and its inflow is then used as input; the water requirement of 1994 is used as design requirement. The average 10-day inflow of 1973 is  $26.47 m^3/s$ , and the average 10-day water requirement is  $34.6 m^3/s$ . The results are presented in Table II, which shows the reservoir performance in hydropower, water release, water deficit and water resource usage. Again, the GA curves have better performance than the M-5 curves.

Table II. The average results of the year 1973 from the simulation of GA and M-5 operating curves

Type of rule curve	Hydropower (10 <sup>6</sup> kw-h)	Release (m <sup>3</sup> /s)	Deficit (m <sup>3</sup> /s)	Water resource usage (%)
M-5	2.42	24.21	5.40	91.5
GA	2.53	26.38	3.98	99.7

### CONCLUSION

Recently, GAs have been finding widespread applications in solving optimization problems in scientific and engineering circles. Their results provide supporting evidence that these algorithms are efficient, adaptive and robust search processes. Moreover, the mechanics of a GA are surprisingly simple, involving nothing more complex than copying strings and swapping partial strings. Simplicity of operation and power of effect are two of the main attractions of the GA approach. In this study, two GAs, binary and real coded, are implemented to search the operating rule curves for a multipurpose reservoir system. The system, which is very complex, includes three input streamflows, one reservoir and hydropower station, five public waterworks, four irrigation areas, one river dam and 12 merge points. A simulation model is developed and used to simulate the reservoir operation, based on a set of rule curves (i.e., a chromosome) generated from a GA. The simulation results, such as water release and reservoir stage, are then fed back to GA to calculate its performance for an objective function value.

The results show that the GAs provide a feasible way to search the operating rule curves, and the curves have much better performance, in terms of shortage index value, water supply deficit and hydropower, than the original (M-5) rule curves. To be more specific, the shortage indexes obtained from a long-term (36 years) reservoir operation by M-5 curves is 15.34 and by GA curves is 8.27, where the shortage index of the GA is only about half that of M-5. The results also indicate that using the shortage index as the objective function in GA is adequate and robust in a reservoir operating for a different purpose, e.g., water supply deficit and hydropower.

Comparing the results of operating rule curves obtained from both binary-coded and real-coded GAs shows that the real-coded GA is more efficient and slightly more accurate than the binary-coded GA. This might be because we use less precision for the binary-coded GA where the string length of each variable is only set as 3. However, for the binary-coded GA, it will be inadequate and/or inefficient to use high precision when a great number of variables, such as in our case which has 36 variables, are to be estimated.

### ACKNOWLEDGEMENTS

This paper is based on partial work supported by the National Science Council, R.O.C. (grant no. NSC 90-2313-B-002-323).

### REFERENCES

- Bennett KP, Ferris MC, Loannidis YE. 1991. A genetic algorithm for database query optimisation. *The Proceedings of the Fourth International Conference on Genetic Algorithms*. San Diego, California: Morgan Kaufmann Publishers, 400–407.
- Brooker LB. 1982. Intelligent Behavior as an Adaptation to the Task Environment. PhD thesis. University of Michigan: Ann Arbor, MI.
- Canfu-Paz E. 2000. *Efficient and Accurate Parallel Genetic Algorithms*. Kluwer Academic: Boston.
- Chang LC, Chang FJ. 2001. Intelligent control for modeling of real time reservoir operation. *Hydrological Processes* **15**(9): 1621–1634.
- Chang FJ, Chen L. 1998. Real-coded genetic algorithm for rule-based flood control reservoir management. *Water Resources Management* **12**: 185–198.
- Chang FJ, Hui SC, Chen YC. 2002. Reservoir operation using grey fuzzy stochastic dynamic programming. *Hydrological Processes* **16**(12): 2395–2408.

- Chang FJ, Lai JS, Kao LS. 2003. Optimization of operation rule curves and flushing schedule in a reservoir. *Hydrological Processes* **17**(8): 1623–1640.
- Chen L. 1995. *A study of optimizing the rule curve of reservoir using object oriented genetic algorithms*. PhD dissertation, Department of Agricultural Engineering, National Taiwan University, Taipei.
- Correa RC, Ferreira A, Rebreyend P. 1999. Scheduling multiprocessor tasks with Genetic algorithm. *IEEE Transactions on Parallel and Distributed Systems* **10**(8): 825–837.
- Davis L. 1991. Hybridization and numerical representation. In *The Handbook of Genetic Algorithms*, Davis L (ed.). Van Nostrand Reinhold: New York; 61–71.
- DeJong KA. 1975. *Analysis of the behavior of a class of genetic adaptive systems*. PhD dissertation, Department of Computer and Communications Sciences, University of Michigan, Ann Arbor, MI.
- Esat V, Hall MJ. 1994. Water resources system optimization using genetic algorithms. In *Proceedings of the 1st International Conference on Hydroinformatics*. Balkema: Rotterdam; 225–231.
- Eshelman LJ, Schaffer JD. 1993. Real-coded genetic algorithms and interval-schemata. In *Foundations of Genetic Algorithms*, Vol. II, Whitley D (ed.). Morgan Kaufmann: San Mateo, CA; 187–202.
- Gill PE, Murray W, Wright MH. 1981. *Practical Optimization*. Academic Press: London.
- Goldberg DE. 1989. *Genetic Algorithms in Search, Optimization, and Machine Learning*, 2nd edn. Addison-Wesley: Reading, MA.
- Goldberg DE. 1994. Genetic and evolutionary algorithms come of age. *Communications of the ACM* **37**(3): 113–119.
- Goldberg DE, Deb K. 1991. A comparative analysis of selection schemes used in genetic algorithms. In *Foundations of Genetic Algorithms*, Rawlins G (ed.). Morgan Kaufmann: San Mateo, CA.
- Goldberg DE, Kuo CH. 1987. Genetic algorithms in pipeline optimization. *Journal of Computing in Civil Engineering, ASCE* **4**(2): 128–141.
- Grefenstette JJ. 1986. Optimization of control parameters for genetic algorithms. *IEEE Transactions on Systems, Man and Cybernetics SMC16(1): 122–128.*
- Holland JH. 1975. *Adaptation in Natural and Artificial Systems*. Massachusetts Institute of Technology: Cambridge, MA.
- Hydrologic Engineering Center (HEC). 1975. *Hydrologic Engineering Methods for Water Resources Development*, Vol. 8, *Reservoir Yield*. US Army Corps of Engineers: Davis, CA.
- Michalewicz Z. 1999. *Genetic Algorithms + Data Structures = Evolution Programs*, 3rd edn. Springer-Verlag: New York.
- Oliveira R, Loucks DP. 1997. Operating rules for multireservoir systems. *Water Resources Research* **33**(4): 839–852.
- Pardalos P, Resende M (eds). 2002. *Handbook of Applied Optimization*. Oxford University Press: New York, USA.
- Schaffer JD, Caruana RA, Eshelman LJ, Das R. 1989. A study of control parameters affecting online performance of genetic algorithms for function optimization. In *Proceedings of the Third International Conference on Genetic Algorithms*, Schaffer JD (ed.). Morgan Kaufmann: San Mateo, CA.
- Sharif M, Wardlaw R. 2000. Multireservoir system optimization using genetic algorithms: case study. *Journal of Computing in Civil Engineering, ASCE* **14**(4): 255–263.
- Simpson AR, Dandy GC, Murphy LJ. 1994. Genetic algorithms compared with other techniques for pipe optimization. *Journal of Water Resources Planning and Management, ASCE* **120**(4): 423–443.
- Wang QJ. 1991. The genetic algorithm and its application to calibrating conceptual rainfall–runoff models. *Water Resources Research* **27**(9): 2467–2471.
- Wardlaw R, Sharif M. 1999. Evaluation of genetic algorithms for optimal reservoir system operation. *Journal of Water Resources Planning and Management, ASCE* **125**(1): 25–33.
- Wright A. 1991. Genetic algorithms for real parameter optimization. In *Foundations of Genetic Algorithms*, Rawlins GJE (ed.). Morgan Kaufmann: San Mateo, CA; 205–218.